



Southwire™

TOOLS & EQUIPMENT

HAND TOOLS CATALOG



**BUILT FOR DURABILITY.
BUILT FOR RELIABILITY.
BUILT FOR WORK.™**

SOUTHWIRETOOLS.COM

OUR STORY

For over 60 years, Southwire has provided high quality electrical wire and cable to the commercial and industrial construction industries. Now, the name you trust provides durable, cutting-edge professional grade tools, designed with safety and productivity in mind. Look to Southwire® for solutions to all your electrical needs, from electrician's hand tools, meters, contractor equipment, temporary power, and extension cords.

SOUTHWIRE, THE COMPANY

Southwire Company, LLC is North America's leading manufacturer of wire and cable used in the distribution and transmission of electricity. Throughout its history, our company has sought to help provide power through our products, our service and by helping empower our customers, employees, and communities. With more than 6,800 people at customer service centers, manufacturing facilities and sales offices throughout North America, we are dedicated to developing the highest-quality products and legendary service.

THE DRIVE FOR EXCELLENCE

Driving for excellence starts with being responsive to our customers and the markets we serve. By creating business units, Southwire Company enables each to foster an entrepreneurial spirit, innovative solutions, and responsiveness required in today's business. At the same time each division can leverage the resources and rich history of Southwire Company as a whole.

THE PRODUCTS

To be successful requires products that give you solutions no matter what stage of the project cycle you are in. Our product teams and dedicated resources work together to listen to and work with our customers, creating solutions that deliver unparalleled value through product innovation, safety and efficiency.

THE SERVICE

Service is more than a word or a phone number; it's a tangible support system that assists you through the entire project cycle. Starting with our own knowledgeable customer service team, to our National Field Sales team, and our District Merchandising Specialists. In the office or in the field, we're there to lend a hand, just when you need it most. Feel free to reach us at 1-855-SWTTOOLS (855-798-6657)

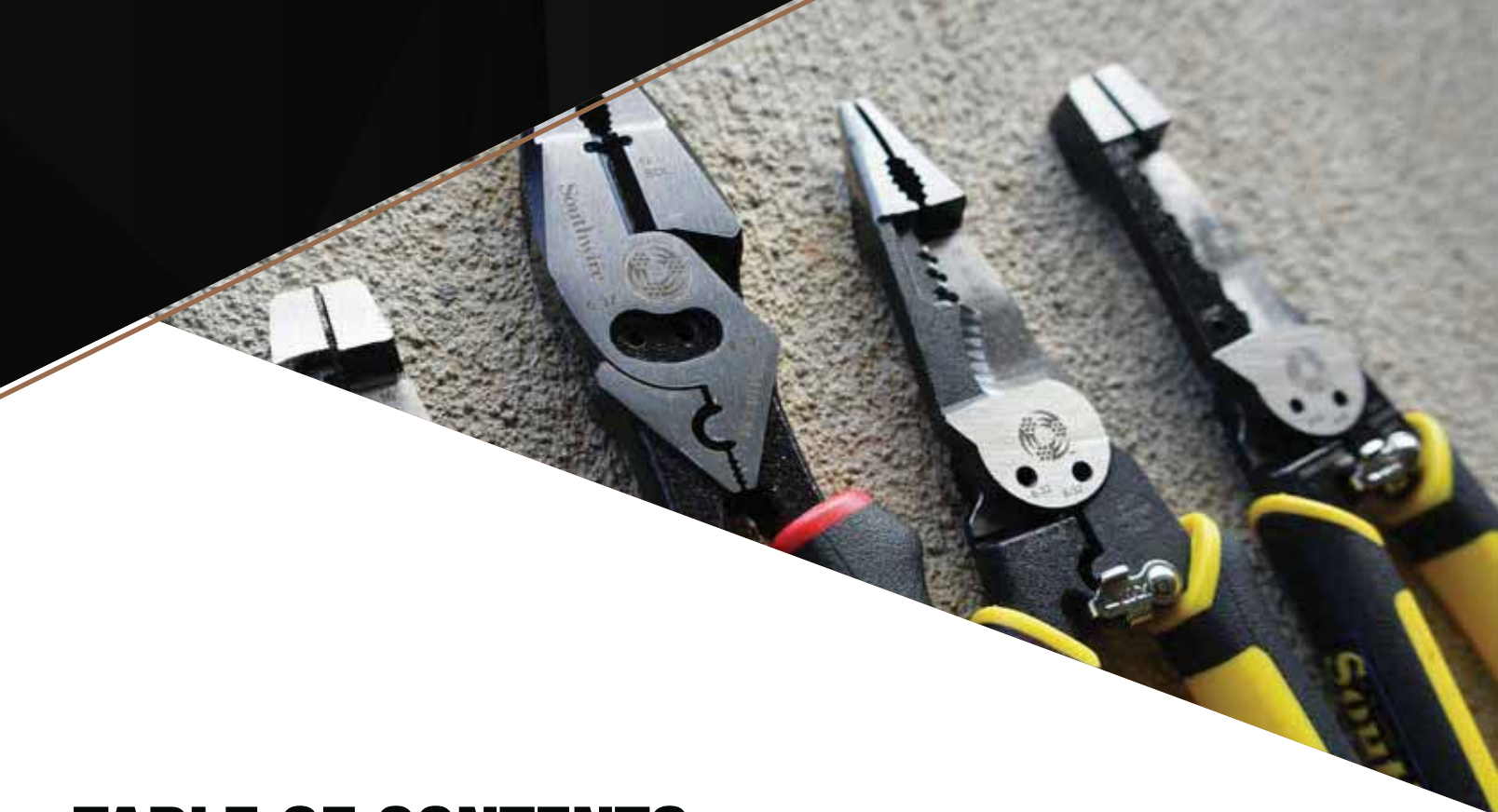

TABLE OF CONTENTS

HAND TOOLS

- High Leverage Side Cutting Pliers 7
- Long Nose Pliers..... 8
- High Leverage Diagonal Cutting Pliers 9
- Cable Cutting Pliers 10
- Terminal Crimping/Cutting Pliers..... 11
- 5-IN-1 Multi-Tool Pliers 12
- Multi-Purpose Side Cutting Pliers..... 12
- Made In USA Pliers 13
- Wire Strippers & Cutters..... 14
- Made In USA Wire Strippers & Cutters..... 16
- Automatic Wire Stripper 16
- Cable Ripper Tool..... 17
- Drywall Jab Saw..... 17
- Conduit Scorer & Cutters 17
- Electrician’s Scissors 18
- Plastic Pipe Cutter 18
- Seaktek™ Cutters 19
- Edgeforce™ & Stainless Steel Knives..... 21
- Screwdrivers 22
- Nutdrivers 31
- Hex Keys..... 32
- Levels 33
- Bags & Accessories 35
- Kits..... 39

VDV HAND TOOLS

- Snips & Scissors..... 42
- Splicing Kit 43
- COAX & Cable Cutters..... 44
- Twisted Pair Cutters/Strippers..... 45
- COAX Wire Stripper 46
- COAX Prep Tool 47
- Punch Down Tools..... 48
- Crimping Tools 49
- Network Tool Kit..... 51
- Crimping Long Nose Pliers 51
- COAX Crimp Tool 52
- Cable TV Tool Kit 54
- COAX 3-IN-1 Crimp Tool..... 55

FISHING & BENDING

- Non-Conductive Tip Fish Tape 57
- Flexible Metal Leader Fish Tape 58
- Fish Tape Tube 59
- Steel Fish Tape 60
- Fish Tape Leader..... 61
- Glow-In-The-Dark Fish Sticks..... 62
- Conduit Benders 63
- Hand Cable Benders 64



Southwire™

TOOLS & EQUIPMENT

THE SOUTHWIRE® ADVANTAGE



12%
EASIER CUTS*

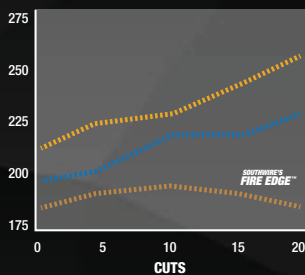

- SOUTHWIRE
- COMPETITOR 1
- COMPETITOR 2

**Based on 3rd Party Force vs Cut Load Cell Testing using Southwire Side Cutting Pliers vs leading national brands.*



2X
MORE HANDLE
STABILITY*

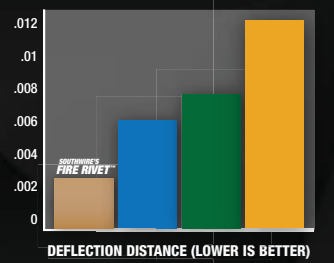

- SOUTHWIRE
- COMPETITOR 1
- COMPETITOR 2
- COMPETITOR 3

**Based on 3rd Party Joint Integrity Testing measuring handle deflection using Southwire Diagonal Cutting pliers vs leading national brands*



2X
EASIER TO
OPEN JAWS*

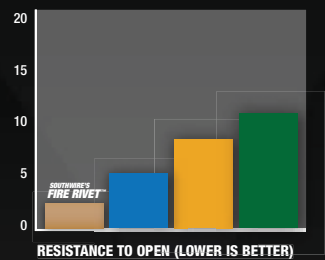

- SOUTHWIRE
- COMPETITOR 1
- COMPETITOR 2
- COMPETITOR 3

**Based on 3rd Party Jaw Opening Testing measuring average force to open plier jaws using Southwire Terminal Crimping Pliers vs leading national brands.*

THE SOUTHWIRE® ADVANTAGE



SCP9TPCB



REAMING HEAD



12AWG SOL WIRE STRIPPER



FIRE EDGE™ BLADES



FIRE RIVET™ TECHNOLOGY



6-32 & 8-32 BOLT SHEARS



CRIMPER & FISHTAPE PULLER



GUARANTEED FOR LIFE

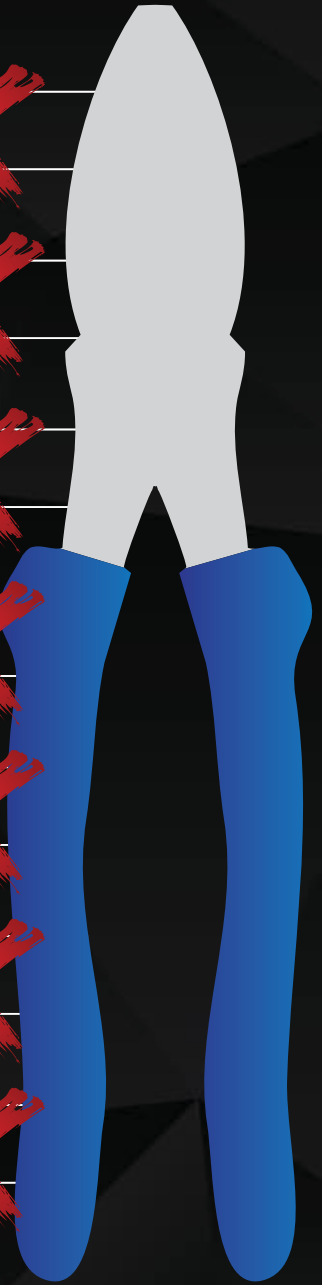

COMPETITOR 1

HAND TOOLS

Your hands are your most important tools, the ones you need for every job. Equip them with high-quality, durable hand tools from Southwire. With a strong yet comfortable design and no-hassle lifetime warranty*, you can rely on these tools to make your life easier and last through years of hard work.

- Pliers
- Cable Management
- Stripping & Cutting
- Drivers
- Measuring & Levels
- Tool Bags, Pouches, & Gloves
- Kits & Accessories



HAND TOOLS

HIGH LEVERAGE SIDE CUTTING PLIERS

SCP9TPCB



SCP9TPC



SCP9C



SCP9



SCP9D



Our high leverage side cutting pliers offer a streamlined design with sure-gripping, cross-hatched knurled jaws.

- Induction-hardened cutting blades ensure efficient and lasting cutting surfaces for hard and soft wire
- Drop forged CRV steel for durability
- File teeth on jaws help remove burrs in conduit
- Curved ergonomic handle for comfortable use

SPECIFICATIONS

COMFORT GRIP

MODEL #	STOCK #	DESCRIPTION		
SCP9TPC	589931	High Leverage Side Cutting Pliers w/ Fish Tape Puller & Crimper		
SCP9C	589930	High Leverage Side Cutting Pliers w/ Crimper		
SCP9	589929	High Leverage Side Cutting Pliers		
SCP9TPCB	65028940	High Leverage Side Cutting Combo Pliers		
	HEIGHT	WIDTH	DEPTH	WEIGHT
SCP9TPC	9.5"	2.5"	0.88"	1.19 lbs
SCP9C	9.5"	2.5"	0.88"	1.19 lbs
SCP9	9.5"	2.5"	0.88"	1.19 lbs
SCP9TPCB	9.00"	3.54"	0.79"	1.16 lbs

DIPPED GRIP

MODEL #	STOCK #	DESCRIPTION		
SCP9D	582898	High Leverage Diagonal Cutting Pliers w/ Dipped Handle		
SCP9CD	587491	High Leverage Diagonal Cutting Pliers w/ Crimper Dipped Handles		
	HEIGHT	WIDTH	DEPTH	WEIGHT
SCP9D	9.5"	2.13"	0.75"	1.19 lbs
SCP9CD	9.5"	2.13"	0.75"	1.19 lbs



HAND TOOLS

LONG NOSE PLIERS

LNP7



Southwire long nose pliers provide a better grip without sacrificing tool strength or durability.

- Knurled jaws for sure-gripping
- Drop forged CRV steel for durability
- High leverage, hot rivet design for smooth action and no handle wobble
- Long nose design for forming and looping wire and handling small parts
- Precision induction-hardened cutting knives for long-lasting cutting edge
- 12 AWG solid wire stripping feature on LNP8S and LNP8SD models

LNP6



SPECIFICATIONS

COMFORT GRIP

MODEL #	STOCK #	DESCRIPTION	HEIGHT	WIDTH	DEPTH	WEIGHT
LNP7	589927	7" Long Nose Pliers w/ Side Cutter				
LNP6	589926	6" Long Nose Pliers w/ Side Cutter				
LNP7			7.13"	2.25"	0.75"	0.36 lbs
LNP6			7"	2.25"	0.75"	0.34 lbs

LNP8SD



LNP7D



DIPPED GRIP

MODEL #	STOCK #	DESCRIPTION	HEIGHT	WIDTH	DEPTH	WEIGHT
LNP8SD	582897	8" Hvy. Dty. Long Nose Pliers Side Cutting Stripper Dipped Handle				
LNP7D	587490	7" Long Nose Pliers w/ Side Cut Dipped Handle				
LNP6D	582896	6" Long Nose Pliers w/ Side Cut Dipped Handle				
LNP8SD			8.38"	2.13"	0.63"	0.64 lbs
LNP7D			7.38"	2.13"	0.63"	0.38 lbs

LNP6D



HAND TOOLS

HIGH LEVERAGE DIAGONAL CUTTING PLIERS

DCP8



The high leverage design of these diagonal cutting pliers provides greater cutting power while the hot riveted joint ensures smooth action with no handle wobble.

- Drop forged CRV steel for durability
- Induction hardened cutting blades ensure efficient and lasting cutting surfaces
- High leverage design provides maximum cutting power
- Hot riveted pivot joint provides smooth action and no wobble
- Effectively cuts most hardened wire, ACSR, bolts, screws, and nails
- Available in dual molded comfort grips and plastic dipped handles

DCPA8



SPECIFICATIONS

COMFORT GRIP

MODEL #	STOCK #	DESCRIPTION		
DCP8	589933	8" High Leverage Diagonal Cutting Pliers		
DCPA8	589932	8" High Leverage Diagonal Cutting Pliers w/ Angled Head		
	HEIGHT	WIDTH	DEPTH	WEIGHT
DCP8	8.25"	2.25"	0.75"	0.73 lbs
DCPA8	8.25"	2.25"	0.75"	0.73 lbs

DCP8D



DCPA8D



DIPPED GRIP

MODEL #	STOCK #	DESCRIPTION		
DCP8D	582894	8" High Leverage Diagonal Cutting Pliers w/ Dipped Handle		
DCPA8D	582895	8" High Leverage Diagonal Cutting Pliers w/ Angled Head and Dipped Handle		
DCP6D	587399	6" High Leverage Diagonal Cutting Pliers Dip Handle		
	HEIGHT	WIDTH	DEPTH	WEIGHT
DCP8D	8"	2"	0.63"	0.61 lbs
DCPA8D	8"	2"	0.63"	0.61 lbs
DCP6D	6"	2"	0.63"	0.40 lbs

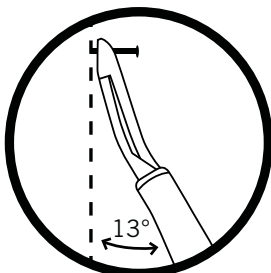

*DCPA8 and DCPA8D



HAND TOOLS

CABLE CUTTING PLIERS

CCP9



The shear type hook jaws grab and hold cable while the shear cutting action allows for clean cuts.

- Heat treated, precision ground blades ensure clean cuts
- Comfortable cushion grips reduce hand fatigue
- Forged steel with black-oxide finish for long life
- High leverage pivot joint ensures smooth action and no handle wobble

CCP9DE



SPECIFICATIONS

COMFORT GRIP

MODEL #	STOCK #	DESCRIPTION		
CCP9	589935	9" High Leverage Cable Cutters		
CCP6	589934	6 1/2" Cable Cutting Shears		
CCPR400	58277705	750MCM Ratcheting Cable Cutter		
CCP350	58277640	350MCM 16" Cable Cutter		
CCPR400S	59556240	600MCM Ratcheting Cable Cutter		
	HEIGHT	WIDTH	DEPTH	WEIGHT
CCP9	9.38"	2.13"	0.63"	0.94 lbs
CCP6	6.75"	2"	0.75"	0.54 lbs
CCPR400	13.78"	6.81"	1.57"	0.51 lbs
CCP350	18.90"	4.53"	1.18"	2.55 lbs
CCPR400S	127.95"	5.71"	1.57"	1.54 lbs

CCPR400



CCP350



CCPR400S



DIPPED GRIP

MODEL #	STOCK #	DESCRIPTION		
CCP9DE	643230	9" High-Leverage Cable Cutters w/ Ergonomic Dipped Handle		
CCP6D	587489	6 1/2" Cable Cutting Shears w/ Dipped Handle		
	HEIGHT	WIDTH	DEPTH	WEIGHT
CCP9DE	9.25"	1.8"	0.62"	1 lbs
CCP6D	6.75"	2"	0.75"	0.51 lbs



TERMINAL CRIMPING/CUTTING PLIERS

TCC9



TCC9D



These high leverage crimping pliers have two die positions that permit the tool to crimp insulated and non-insulated terminals and ferrules.

- Tapered nose for working in confined spaces
- Crimps 10-22 AWG solderless terminals and connectors
- Specially hardened wire cutter in nose
- Curved handle and ergonomic molded grip for comfortable use
- Crimps insulated and non-insulated terminals and connectors

SPECIFICATIONS

MODEL #	STOCK #	DESCRIPTION		
TCC9	US: 589936	Terminal Crimper Cutter w/ Comfort Grip Handle		
TCC9D	582899	Terminal Crimper Cutter w/ Dipped Handle		
	HEIGHT	WIDTH	DEPTH	WEIGHT
TCC9D	9.75"	2.38"	0.63"	0.79 lbs
TCC9	9.38"	1.88"	0.75"	0.86 lbs

HAND TOOLS

HAND TOOLS | PLIERS

5-IN-1 MULTI-TOOL PLIERS

S7N1HD



S816SOLHD



SNM1214HD



This versatile pair of spring action pliers performs multiple functions.

- Multi-functional pliers: grips, strips, crimps, reams, and cuts
- Narrow knurled jaw allows access to tight spaces
- Cuts small gauge copper wire and communication cables
- Crimps common size wire ferrules
- Reams and smooths thin-wall conduit ends
- Easily strips 10-14 AWG solid wire
- Durable forged construction for lasting performance
- Comfortable grips minimize hand wear and fatigue

SPECIFICATIONS

MODEL #	STOCK #	DESCRIPTION		
S7N1HD	US: 65028440	7-in-1 Long Nose Multi-Tool Pliers		
S816SOLHD	65028140	Linesman Wire Stripper 8-16 AWG Solid 10-18 AWG Stranded		
SNM1214HD	65028240	Wire Stripper 12-14 AWG Solid w/ Ergo Grip		
	HEIGHT	WIDTH	DEPTH	WEIGHT
S7N1HD	10.24"	3.54"	0.98"	0.79 lbs
S816SOLHD	10.24"	3.54"	0.98"	0.71 lbs
SNM1214HD	10.04"	3.54"	0.79"	0.74 lbs

MULTI-PURPOSE SIDE CUTTING PLIER

MPSCP



Multi-Purpose Side Cutting Plier cuts ACSR, screws, nails, and most hardened wire.

- Drop forged construction for durability
- High-leverage pivot joint or easier cuts
- Strips 8-14 AWG solid wire and 10-16 stranded wire
- 6-32 and 8-32 screw shearing

SPECIFICATIONS

MODEL #	STOCK #	DESCRIPTION		
MPSCP	597244	Multi-Purpose Side Cutting Plier		
	HEIGHT	WIDTH	DEPTH	WEIGHT
MPSCP	11.38"	3.75"	1.50"	0.6 lbs

HAND TOOLS

MADE IN USA PLIERS

SCP9TPCD-US



DCPA8D-US



CCP9D-US



TCC9D-US



Made from American forged steel, these tools are built to withstand jobsite wear and tear. Assembled with hot rivet technology, these pliers are designed to be the livelihood of every professional.

- Hot riveted pivot joint for smooth action
- Induction hardened
- Hand sharpened blades
- Drop forged USA steel for durability

SPECIFICATIONS

MODEL #	STOCK #	DESCRIPTION
SCP9TPCD-US	648073	Made in USA 9" High-Leverage Side Cutting Pliers w/ Fish Tape Puller, Crimper, & Dipped Grip Handles
DCPA8D-US	648075	Made in USA 8" Angled Head High-Leverage Diagonal Cutting Pliers w/ Dipped Handles
CCP9D-US	648076	Made in USA 9" High-Leverage Cable Cutters w/ Dipped Grip Handles
TCC9D-US	648077	Made in USA 9" Terminal Crimper/Cutter w/ Dipped Grip Handles

	HEIGHT	WIDTH	DEPTH	WEIGHT
SCP9TPCD-US	11.75"	3.88"	11.75"	1.1 lbs
DCPA8D-US	10.13"	3.88"	10.13"	0.6 lbs
CCP9D-US	11.75"	3.88"	11.75"	1.05 lbs
TCC9D-US	11.75"	3.88"	11.75"	0.9 lbs

 **WE'VE GOT IT
MADE IN AMERICA™**

HAND TOOLS

WIRE STRIPPERS & CUTTERS

S1018SOL



S612STR



S1018STR



S1626STR



Made of stainless steel, these wire strippers have precision ground stripping holes and are fitted with comfortable double-dipped plastic grips.

- Stainless steel construction is durable and rust-proof
- Serrated nose grasps the cable for easy twisting and pulling
- Double-dipped grip provides comfortable feel
- Spring loaded for self-opening action
- Specially designed cutting blades provide fast and clean wire stripping and cutting

SPECIFICATIONS

MODEL #	STOCK #	DESCRIPTION		
S1018SOL	582780	Wire Stripper Cutter 10-18SOL;12-20 Stranded Ergonomic Handle		
S1018STR	582781	Compact Stripper Cutter 10-18 AWG Solid		
S612STR	582779	Wire Stripper Cutter 6-12 AWG Stranded Ergonomic Handle		
S1626STR	582782	Compact Stripper Cutter 16-26 AWG Stranded		
HEIGHT	WIDTH	DEPTH	WEIGHT	
S1018SOL	7.63"	8.38"	0.69"	0.33 lbs
S1018STR	6.25"	2.38"	0.69"	0.29 lbs
S612STR	7.38"	2.5"	0.63"	0.33 lbs
S1626STR	6.25"	2"	0.69"	0.28 lbs

HAND TOOLS

WIRE STRIPPERS & CUTTERS

SNM1012



SNM1214



MP61



MPLN



SVN



Made of stainless steel, these wire strippers have precision ground stripping holes and are fitted with comfortable double-dipped plastic grips.

- Stainless steel* construction is durable and rust-proof
- Serrated nose grasps the cable for easy twisting and pulling
- Specially designed cutting blades provide fast and clean wire stripping and cutting
- Double-dipped grip provides comfortable fit
- Spring loaded for self-opening action (on models SNM1012, SNM1214)

SPECIFICATIONS

MODEL #	STOCK #	DESCRIPTION		
SNM1012	582784	NM Cable Stripper Cutter 10-12 AWG Ergonomic Handle		
SNM1214	582785	NM Cable Stripper Cutter 12-14 AWG Ergonomic Handle		
MP61	582789	6-in-1 Multipurpose Stripper		
MPLN	582788	Long Nose Multipurpose Tool		
SVN	582787	Wire Stripper V-Notch		
	HEIGHT	WIDTH	DEPTH	WEIGHT
SNM1012	8.13"	2.19"	0.69"	0.36 lbs
SNM1214	7.88"	2.19"	0.69"	0.36 lbs
MP61	9"	2.38"	0.69"	0.43 lbs
MPLN	8.5"	2.38"	0.75"	0.36 lbs
SVN	5.25"	2.31"	0.44"	0.14 lbs

*Excludes SVN

HAND TOOLS | STRIPPING & CUTTING

HAND TOOLS

MADE IN USA WIRE STRIPPERS & CUTTERS

S1020SOL-US



S1018SOL-US



SNM1214HH-US



Made from durable, heat-treated steel, the Made in USA Wire Strippers & Cutters are equipped to handle day-to-day jobsite demands.

- Made from durable heat-treated steel for longer life
- Double-dipped grip for comfortable fit
- Serrated nose holds cable for easy twisting and pulling
- Spring-loaded for self-opening action
- Not intended for cutting bolts or steel wire

SPECIFICATIONS

MODEL #	STOCK #	DESCRIPTION		
S1020SOL-US	648079	Made in USA 10-20 AWG SOL & 12-22 AWG Compact Wire Stripper/Cutter		
S1018SOL-US	648080	Made in USA 10-18 AWG SOL & 12-20 AWG STR Ergo Wire Stripper/Cutter		
SNM1214HH-US	65172140	Made in USA Romex® Box BoxJaw™ Wire Strippers 12-14AWG SOL		
	HEIGHT	WIDTH	DEPTH	WEIGHT
S1020SOL-US	8.63"	3.88"	8.63"	0.32 lbs
S1018SOL-US	9.34"	3.88"	9.34"	0.37 lbs
SNM1214HH-US	9.75"	4.00"	1.75"	0.45 lbs

 **WE'VE GOT IT
MADE IN AMERICA™**

AUTOMATIC WIRE STRIPPER

SA822



With this wire stripper, insert a wire, squeeze the handles, and you're finished.

- Strips 8-22 AWG wire quickly and easily
- Removes up to 1" of jacket layer with single step
- Spring design returns wire to ready position after stripping

SPECIFICATIONS

MODEL #	STOCK #	DESCRIPTION		
SA822	582786	Automatic Wire Stripper 8-22 AWG		
	HEIGHT	WIDTH	DEPTH	WEIGHT
SA822	7"	3.38"	1.13"	0.81 lbs

CABLE RIPPER TOOL

CRT



This NM-B cable ripper makes cable jacket removal quick and easy. It slits the cable jacket with one easy stroke.

- Makes end or mid-run slits to expose insulated wires
- Easily slits the outer jacket on NM-B cable
- Accurate wire measuring gauge holes from 6 to 14 AWG solid wire

SPECIFICATIONS

MODEL #	STOCK #	DESCRIPTION		
CRT	582933	Cable Ripper Tool		
HEIGHT	WIDTH	DEPTH	WEIGHT	
CRT	3.68"	1.88"	1.38"	.05 lbs

DRYWALL JAB SAW

DESAW



Our Drywall Jab Saw is designed with a triple cut blade for a fast and efficient cut. The sharp tip excels at plunge cutting, and its aggressive tooth design cuts fast.

- Hardened and tempered steel blade for long lasting durability and strength
- Sharp cross-ground teeth cut through drywall, wood, or plastic
- Over molded cushion handle for comfort and firm grip
- 7" blade with cross-grained teeth cuts drywall in both directions

SPECIFICATIONS

MODEL #	STOCK #	DESCRIPTION		
DESAW	582824	Drywall Jab Saw		
HEIGHT	WIDTH	DEPTH	WEIGHT	
DESAW	12"	1.63"	1.13"	0.29 lbs

CONDUIT SCORER AND CUTTER

CONCUT



Cut copper, aluminum, and brass tubing as well as galvanized thin wall conduit in a few revolutions.

- Scores and cuts EMT conduit
- Cutting wheel can be changed quickly and easily

SPECIFICATIONS

MODEL #	STOCK #	DESCRIPTION		
CONCUT	582820	Conduit Scorer and Cutter		
HEIGHT	WIDTH	DEPTH	WEIGHT	
CONCUT	5.25"	2"	1.5"	0.96 lbs

HAND TOOLS

ELECTRICIAN'S SCISSORS

ES001



Unlike regular scissors or shears, the serrated blades keep wire from slipping out of the jaws, so that cutting through hardware cloth, cable, wire netting, and other difficult-to-cut materials becomes an easy task.

- Durable nickel-plated steel for resistance from rust and corrosion
- Strips 19 AWG & 23 AWG
- Scraper and file on outside of both blades
- Cuts up to 16 AWG solid and 12 AWG stranded wire

SPECIFICATIONS

MODEL #	STOCK #	DESCRIPTION		
ES001	582835	Electrician's Scissors		
HEIGHT	WIDTH	DEPTH	WEIGHT	
ES001	5.38"	2.19"	0.38"	0.19 lbs

PLASTIC PIPE CUTTER

PLACUT



Our plastic pipe and tubing cutter has non-slip grips and a strong stainless steel blade that makes cutting plastic tubing easy.

- Easily performs flush cuts on rigid plastic tubing
- Durable design for rugged use
- Locking latch allows easy one-handed operation
- Cuts up to 3/4" PVC and 1-5/8" flexible tubing

SPECIFICATIONS

MODEL #	STOCK #	DESCRIPTION		
PLACUT	582821	Plastic Pipe Cutter		
HEIGHT	WIDTH	DEPTH	WEIGHT	
PLACUT	8.75"	1.83"	1.17"	0.35 lbs

HAND TOOLS

ROTO-SPLIT® CUTTERS



RS-101

The Seatek™ RS-101 will become your everyday cutter for MC Cable. It features a thumb screw to clamp and release the cable. It is simple, straight forward, and easy to use. You'll never do another MC Cable job without it. Proudly made in the USA.

- Cuts and strips any armored cable from AWG 14-2 to 10-4 as well as AC, MC & HCF cables
- After initial setting only a half turn of the thumb screw is needed to clamp or release the cable
- Make cuts quickly and easily in tight quarters
- Durable die cast epoxy-enameled body

SPECIFICATIONS

MODEL #	STOCK #	DESCRIPTION			
RS-101	598165	Original RS-101 Roto-Split® Cutter			
RS-101A	598166	RS-101A Super Roto-Split® Cutter			
RS-101AC	598167	RS-101AC Automatic Roto-Split® Cutter			
	WEIGHT	MIN OPENING	MAX OPENING	FLEX (TRADE SIZE)	AWG SOL OR MC RANGE
RS-101	1.2 lbs	0.375	0.75	3/8"	14-2 to 8-4
RS-101A	1.2 lbs	0.375	0.75	3/8"	14-2 to 8-5
RS-101AC	1.2 lbs	0.375	0.75	3/8"	14-2 to 8-6



**WE'VE GOT IT
MADE IN AMERICA™**

ROTO-FLEX® CUTTERS

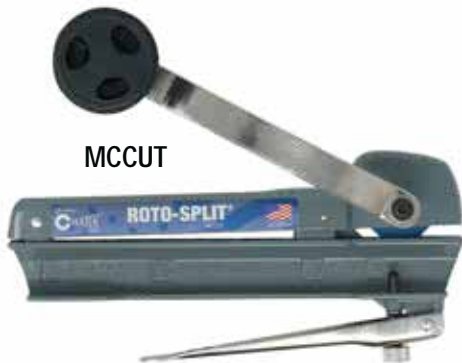

MCCUT

Easily handles all common MC, BX, and flex cables. Securely holds cable in place and releases quickly.

- Quickly splits the armored jacket on 14-2 to 10-4 armored cables and 3/8" flexible conduit with a few turns of the handle
- Adjustable cutting depth for standard and reduced diameter BX/MC cables
- Stores up to 6 extra blades in handle knob
- Durable die cast epoxy enameled construction

SPECIFICATIONS

MODEL #	STOCK #	DESCRIPTION			
RF-120A	598162	RF-120A 1/2" – 3/4" Roto-Flex™ Cutter			
RF-170	598164	RF-170 Giant Roto-Flex™ Cutter			
MCCUT	582822	BX MC Rotary Cutter w/Lever			
MCCBLADE	582823	BX MC Replacement Blade (1 blade/pack)			
	WEIGHT	MIN OPENING	MAX OPENING	FLEX (TRADE SIZE)	AWG SOL OR MC RANGE
RF-120A	1.25 lbs	0.75	1.13	1/2" - 3/4"	4-4 to 2-4
RF-170	1.2 lbs	0.82	1.13	1/2" - 1-1/2"	4-2 to 2-4
	HEIGHT	WIDTH	DEPTH	WEIGHT	
MCCUT	7.5"	1.75"	3.5"	1.1875 lbs	
MCCBLADE	1"	1"	.06"	.006 lbs	



**WE'VE GOT IT
MADE IN AMERICA™**

HAND TOOLS

STRIP-ALL® STRIPPERS

SA-200SK



The Seatek™ SA-200SK is perfect for stripping flat cable. It is a very helpful tool that makes stripping cable faster. It can straight cut jacketed cables up to 5/8" and ring cut cables up to 1/2". Great for the electrician. The best part? This tool is proudly made in the USA.

- Extremely accurate
- Calibrated micrometer dial for precise depth of cut adjustment
- Handy, built-in wire stripper on all models
- Equipped with an extra-sharp, surgical type blade cartridge which easily slices through cable jackets

SPECIFICATIONS

MODEL #	STOCK #	DESCRIPTION	WEIGHT	MIN OPENING	MAX OPENING	FLEX (TRADE SIZE)	AWG SOL OR MC RANGE
SA-200SK	598173	SA-200SK Strip-All® Stripper with Knife	.25 lbs	1/4"	5/8"	5-1/4"	4/0'
SA-200S	598172	SA-200SK Strip-All® Stripper without Knife	.25 lbs	1/4"	5/8"	5-1/4"	4/0'
SA-200L	598171	SA-200L Large Strip-All® Stripper	.25 lbs	3/8"	7/8"	5-1/4"	14-2 to 6-3

 **WE'VE GOT IT
MADE IN AMERICA™**

VEE-TWIN™ STRIPPER

VT-270



The Vee-Twin™ Stripper makes it easy to strip difficult rubber cable as well as plastic jacket cables with its 90° rotating blade, which can be used for ring-cutting and straight-cutting. The VT-270 is perfect for precise cuts in thick cable. It is also great for stripping bulk amounts of cable. Proudly made in the USA.

- Depth of cut setting is extremely accurate to .001" due to a precision micrometer
- Useful for cable sizes ranging from 5/16" to 2-1/8" O.D.
- Used on entrance cable, plenum, multi-pair, and tray cables
- Strips plastic jackets from liquid-tight, flex, or MC
- Blade can be easily replaced
- Body is nickel plated steel for increased durability

SPECIFICATIONS

MODEL #	STOCK #	DESCRIPTION	WEIGHT	MIN OPENING	MAX OPENING	MAX CUT DEPTH	AWG SOL OR MC RANGE
VT-270	598177	VT-270 Vee-Twin™ Stripper	0.7 lbs	5/16"	2-1/8"	1/4"	14-2 to 4/0

 **WE'VE GOT IT
MADE IN AMERICA™**

HAND TOOLS

EDGEFORCE™ & STAINLESS STEEL KNIVES

UTILQ0



CDPK



HBKN



HBKND2



UTILAR



TBKND2-CAMO



CSPKD2



DPKD2



Our knives feature a durable 8CR13MOV stainless steel blade with a black oxide finish and liner lock that keeps the blade secure. Our compact pocket knife is perfect for everyday carry and our hawk bill knife is the perfect pocket knife for pull cuts and splicing.

- Corrosion resistant
- Liner lock keeps blade secure
- Dual thumb studs for right or left hand opening
- Comfort grip for maximum hold and comfort
- Edgeforce™ D2 steel

SPECIFICATIONS

MODEL #	STOCK #	DESCRIPTION	HEIGHT	WIDTH	DEPTH	WEIGHT
UTILQ0	65029040	Folding Utility Knife	6.85"	1.61"	0.45"	0.30 lbs
CDPK	65029340	Compact Pocket Knife	6.74"	1.05"	0.45"	0.10 lbs
HBKN	65029440	Hawkbill Folding Knife	7.24"	1.57"	0.45"	0.25 lbs
HBKND2	65029640	EDGEFORCE™ Hawk Bill Knife	7.24"	1.57"	0.45"	0.25 lbs
UTILAR	65029240	Auto Retracting Utility Knife	6.01"	0.45"	0.45"	0.30 lbs
TBKND2-CAMO	65029840	EDGEFORCE™ Tanto Knife	8.18"	1.68"	0.45"	0.25 lbs
CSPKD2	65029740	EDGEFORCE™ Sheepsfoot Knife	7.28"	4.33"	0.79"	0.23 lbs
DPKD2	65029540	EDGEFORCE™ Drop Point Knife	7.09"	4.33"	0.79"	0.33 lbs

HAND TOOLS

KEYSTONE TIP SCREWDRIVERS

SD1/4K4US



SD5/16K6US



Our USA keystone tip screwdrivers are constructed to handle the toughest jobs with ease. The cushion grip handles allow for maximum torque and comfort. These screwdrivers come with high quality, precision machined tips for an exact fit.

- 22% Larger cushion grip handle provides ultimate comfort and maximum torque
- Corrosion resistant shank
- Tether hole for tether or lanyard attachment
- No-hassle lifetime warranty

SPECIFICATIONS

MODEL #	STOCK #	DESCRIPTION		
SD1/4K4US	65139240	1/4" Keystone Tip Screwdriver		
SD5/16K6US	65139340	5/16" Keystone Tip Screwdriver		
HEIGHT	WIDTH	DEPTH	WEIGHT	
SD1/4K4US	11.88"	1.35"	2.43"	0.30 lbs
SD5/16K6US	13.88"	1.35"	2.43"	0.45 lbs
SHANK TYPE	SHANK LENGTH	TIP TYPE		
SD1/4K4US	Round	4"	Keystone	
SD5/16K6US	Round	6"	Keystone	



**WE'VE GOT IT
MADE IN AMERICA™**

HAND TOOLS

CABINET TIP SCREWDRIVERS

SD1/4C4US



SD1/4C6US



SD3/16C4US



SD3/16C6US



SD3/16C8US



Our USA cabinet tip screwdrivers are constructed to handle the toughest jobs with ease. The cushion grip handles allow for maximum torque and comfort. These screwdrivers come with high quality, precision machined tips for an exact fit.

- 22% Larger cushion grip handle provides ultimate comfort and maximum torque
- Corrosion resistant shank
- Tether hole for tether or lanyard attachment
- No-hassle lifetime warranty

SPECIFICATIONS

MODEL #	STOCK #	DESCRIPTION		
SD1/4C4US	65138740	1/4" Cabinet Tip Screwdriver		
SD1/4C6US	65138840	1/4" Cabinet Tip Screwdriver		
SD3/16C4US	65138940	3/16" Cabinet Tip Screwdriver		
SD3/16C6US	65139040	3/16" Cabinet Tip Screwdriver		
SD3/16C8US	65139140	3/16" Cabinet Tip Screwdriver		
	HEIGHT	WIDTH	DEPTH	WEIGHT
SD1/4C4US	11.88"	1.35"	2.43"	0.30 lbs
SD1/4C6US	13.88"	1.35"	2.43"	0.35 lbs
SD3/16C4US	11.88"	1.28"	2.43"	0.20 lbs
SD3/16C6US	13.88"	1.28"	2.43"	0.20 lbs
SD3/16C8US	15.88"	1.28"	2.43"	0.20 lbs
	SHANK TYPE	SHANK LENGTH	TIP TYPE	
SD1/4C4US	Round	4"	Cabinet	
SD1/4C6US	Round	6"	Cabinet	
SD3/16C4US	Round	4"	Cabinet	
SD3/16C6US	Round	6"	Cabinet	
SD3/16C8US	Round	8"	Cabinet	

 **WE'VE GOT IT
MADE IN AMERICA™**

HAND TOOLS | DRIVERS

HAND TOOLS

PHILLIPS TIP SCREWDRIVERS

SD1P3US



SD2P4US



Our USA phillip tip screwdrivers are constructed to handle the toughest jobs with ease. The cushion grip handles allow for maximum torque and comfort. These screwdrivers come with high quality, precision machined tips for an exact fit.

- 22% Larger cushion grip handle provides ultimate comfort and maximum torque
- Corrosion resistant shank
- Tether hole for tether or lanyard attachment
- No-hassle lifetime warranty

SPECIFICATIONS

MODEL #	STOCK #	DESCRIPTION		
SD1P3US	65139440	#1 Phillips Head Screwdriver		
SD2P4US	65139540	#2 Phillips Head Screwdriver		
	HEIGHT	WIDTH	DEPTH	WEIGHT
SD1P3US	10.88"	1.28"	2.43"	0.25 lbs
SD2P4US	11.88"	1.35"	2.43"	0.30 lbs
	SHANK TYPE	SHANK LENGTH	TIP TYPE	
SD1P3US	Round	3"	Phillips	
SD2P4US	Round	4"	Phillips	

 **WE'VE GOT IT
MADE IN AMERICA™**

HAND TOOLS

SQUARE TIP SCREWDRIVERS

SDQ2P4US



The USA #2 square tip screwdriver has a #2 square tip head with 4" shank. The cushion grip handle allows for maximum torque and comfort. This driver has a 22% larger cushion grip handle that provides ultimate comfort and maximum torque *as compared to previous generations. The corrosion resistant shank ensures durability to withstand damaged, allowing for a longer life. This screwdriver comes with high quality, precision machined tips for an exact fit. A tether hole is provided for feather/lanyard attachment for added convenience. Patent pending.

- 22% Larger cushion grip handle provides ultimate comfort and maximum torque
- Corrosion resistant shank
- Tether hole for tether or lanyard attachment
- No-hassle lifetime warranty

SPECIFICATIONS

MODEL #	STOCK #	DESCRIPTION		
SDQ2P4US	65139740	#2 Square Tip Screwdriver		
	HEIGHT	WIDTH	DEPTH	WEIGHT
SDQ2P4US	11.88"	1.35"	2.43"	0.35 lbs
	SHANK TYPE		SHANK LENGTH	TIP TYPE
SDQ2P4US	Square		4"	Square

 **WE'VE GOT IT
MADE IN AMERICA™**

HAND TOOLS | DRIVERS

HAND TOOLS

8-PIECE CUSHION GRIP SCREWDRIVER SET



SDSET8US

All-purpose assortment of frequently used screwdrivers.

- Comfortable cushion grip handle offers slip resistance and greater torque
- Precision tips for an exact fit
- Handles marked for easy identification
- Includes 8 pieces: 3/16"x4", 3/16"x6" and 1/4"x4" slotted tip, 1/4"x4" and 5/16"x6" keystone tip, #1x3", #2x4", Phillips tip, and #2x4" square tipped screwdrivers

3-PIECE INSULATED SCREWDRIVER SET

SDISET3



This screwdriver set comes with 3 insulated drivers that are tested to the ASTM F1505 international standard and provide 1000 volt insulated protection.

- 1000 volt insulated protection
- Tested to ASTM F1505 international standard
- Durable molded insulation offers visual wear indication
- Includes #2 Phillips x 4" shank, 1/4" slotted x 4" shank, and 3/16" slotted x 6" shank

SPECIFICATIONS

MODEL #	STOCK #	DESCRIPTION	HEIGHT	WIDTH	DEPTH		INCLUDES
SDSET8	582845	8-Piece Cushion Grip Screwdriver Set	11"	1.25"	1.25"	0.13 lbs	SD3/16C4, SD3/16C6, SD1/4K4HD, SD1/4C4, SD5/16K6HD, SD1P3, SD2P4HD, SDQ2P4
SDISET3	65172040	3 Piece Insulated Screwdriver Set	12.99"	5.71"	1.57"	0.89 lbs	#2 Phillips x 4" shank, 1/4" Slotted x 4" shank, 3/16" Slotted x 6" shank

HAND TOOLS

CONDUIT FITTING REAMING SCREWDRIVER

SDCFR



Removable conduit reaming screwdriver deburs thin wall conduit with speed and ease.

- Reams and smooths 1/2", 3/4", and 1" thin-wall conduit ends to protect wire and permit correct installation of fittings
- Reams inside and outside of conduit simultaneously
- Cushion grip handles for comfort and use
- Detachable head can also be used in a drill

SPECIFICATIONS

MODEL #	STOCK #	DESCRIPTION		
SDCFR	582837	Conduit Fitting Reaming Screwdriver		
	HEIGHT	WIDTH	DEPTH	WEIGHT
SDCFR	7.5"	1.25"	1.25"	0.59 lbs

HAND TOOLS

MULTI-BIT/ADJUSTABLE/ROTARY SCREWDRIVERS

SD4N1C



SD4N1P



SD6N1P



SD9N1



SD2N1AL



SD4N1C

- Rotary action screwdrivers facilitate fast and easy screw installation and removal.
- Magnetic Bit Holder
- Chrome plated finish for corrosion resistance
- Heavy Duty steel shanks with bolsters for wrench assisted turning

SD4N1P

- Precision screwdrivers make work in small spaces easier.
- Includes: 1/8" and 3/32" slotted, #0 and #00 phillips
- Spinning cap for controlled one handed use
- Patent pending cushion grip handle

SD6N1P

- Comes with a precision bit allowing easier work in small spaces.
- #0 Phillips bit for precision work
- Chrome plated finish for corrosion resistance
- Comfort grip handle provides extra comfort and maximum torque

SD9N1

- Convenient multi-tool screwdriver with nine tools in one.
- Comfortable cushioned grip allows firm grip and greater torque.
- Precision-machined tips reduce slipping
- Integral flanges provide a solid, twist-resistant blade anchor

SD2N1AL

- Allows for extending and shortening of the shank for work in different places
- Adjustable from 4" to 8"
- Pull collar down to extend shank and pull up to shorten
- Zinc plated finish for corrosion resistance

SPECIFICATIONS

MODEL #	STOCK #	DESCRIPTION	HEIGHT	WIDTH	DEPTH	WEIGHT
SD4N1C	65028540	4-in-1 Magnetic Rotary Driver	9.30"	3.54"	1.38"	0.75 lbs
SD4N1P	65117240	4-in-1 Magnetic Screwdriver w/ Precision Bit	7.99"	3.54"	0.39"	0.16 lbs
SD6N1P	65028840	6-in-1 Screwdriver w/ Precision Bit	11.06"	3.58"	1.30"	0.60 lbs
SD9N1	58285640	9-in-1 Multi Tool Screwdriver	11.02"	3.54"	1.57"	0.55 lbs
SD2N1AL	65028640	2-in-1 Adjustable Length Screwdriver	11.02"	3.54"	1.57"	0.75 lbs
TIP TYPE						
SD4N1C	#1 & #2 Phillips, 3/16" & 1/4" Slotted					
SD4N1P	1/8" and 3/32" slotted, #0 and #00 phillips					
SD6N1P	5/16" & 1/4" nut drivers, #1 & #0 Phillips, 1/4" & 3/16" Slotted					
SD9N1	1/4", 3/8", & 5/16" Hex, #1 & #2 Phillips, 1/4" & 3/16" Slotted, #1 & #2 Square					
SD2N1AL	#2 Phillips, 1/4" Slotted					

12-IN-1 MULTI-BIT SCREWDRIVER



The 12-in-1 Multi-Bit Screwdriver has precision-machined, quick change bits.

- Precision-machined, quick change bits for driving hex, Phillips, slotted, and square head screws
- Handles 3/16", 1/4", 5/16" slotted; #1, #2, #3 Phillips; #1, #2, square recessed; and 1/4", 5/16", 3/8", 1/2" hex drive
- Cushion grip handle provides extra comfort and maximum torque
- Premium chrome-plated shaft is durable as well as rust and corrosion resistant
- Meets ANSI/ASME specifications

SPECIFICATIONS

MODEL #	STOCK #	DESCRIPTION		
SD12N1	59723901	12-in-1 Multi-Bit Screwdriver		
	HEIGHT	WIDTH	DEPTH	WEIGHT
SD12N1	11.75"	3.25"	1.38"	0.85 lbs

9-IN-1 RATCHETING SCREWDRIVER



9-in-1 Ratcheting Multi-Tool Screwdriver allows for quick driving of screws and nuts.

- Precision-machined, quick change bits for driving hex, Phillips, slotted, and square head screws
- Handles 1/4", 3/8", 5/16" hex; #1 and #2 Phillips; 1/2" and 3/16" slotted; #1 and #2 square
- Cushion grip handle provides extra comfort and maximum torque
- Premium chrome-plated shaft is durable as well as rust and corrosion resistant
- Meets ANSI/ASME specifications

SPECIFICATIONS

MODEL #	STOCK #	DESCRIPTION		
SDR9N1	59724001	9-in-1 Ratcheting Screwdriver		
	HEIGHT	WIDTH	DEPTH	WEIGHT
SDR9N1	11.38"	3.75"	1.50"	0.6 lbs

HAND TOOLS

6-IN-1 STUBBY MULT-BIT SCREWDRIVER

SDS6N1



The 6-in-1 Multi-Bit Screwdriver features precision-machined, quick change bits.

- Includes 2 double sided screwdriver bits and 1 double sided nut driver
- Sizes include 5/16" & 1/2" hex, #1 & #2 Phillips, & 3/16" & 1/4" slotted tips
- Cushion grip handles for added comfort and improved torque
- Durable chrome-plated shaft is rust and corrosion resistant

SPECIFICATIONS

MODEL #	STOCK #	DESCRIPTION		
SDS6N1	587397	6-in-1 Stubby Multi-Bit Screwdriver		
	HEIGHT	WIDTH	DEPTH	WEIGHT
SDS6N1	3.50"	1.25"	1.25"	.20 lbs

REVERSIBLE-SHANK SCREWDRIVER

SDREV-1



This reversible screwdriver has the two screwdriver sizes needed to work on wall plates and outlets.

- Phillips #1, Cabinet Tip #2
- Shank is easily reversed

SPECIFICATIONS

MODEL #	STOCK #	DESCRIPTION
SDREV-1	587460	Reversible-Shank Screwdriver

HAND TOOLS

NUT DRIVERS

ND7/16-3US



ND1/2-3US



ND1/4-3US



ND3/8-3US



ND11/32-3US



ND3/16-3US



ND5/16-3US



ND6N1HD



NDS5N1



This line of USA nut drivers includes 7 new nut drivers, including a 7 piece set. The nut drivers have 22% larger cushion grip handles that provides ultimate comfort and maximum torque *as compared to previous generations. The corrosion resistant shank ensures durability to withstand damaged, allowing for a longer life. A tether hole is provided for feather/lanyard attachment for added convenience. Patent pending.

- 22% Larger cushion grip handle provides ultimate comfort and maximum torque
- Corrosion resistant shank
- Tether hole for tether or lanyard attachment
- No-hassle lifetime warranty

SPECIFICATIONS

MODEL #	STOCK #	DESCRIPTION					
ND7/16-3US	65138340	7/16" Nut Driver					
ND1/2-3US	65137840	1/2" Nut Driver					
ND1/4-3US	65137940	1/4" Nut Driver					
ND3/8-3US	65138140	3/8" Nut Driver					
ND11/32-3US	65138540	11/32" Nut Driver					
ND3/16-3US	65138440	3/16" Nut Driver					
ND5/16-3US	65138240	5/16" Nut Driver					
ND6N1HD	65028740	6-in-1 Heavy Duty Nut Driver					
NDS5N1	65116540	5-in-1 Stubby Nut Driver					
NDSET7US	65138640	7 Piece Nut Driver Set					
			HEIGHT	WIDTH	DEPTH	WEIGHT	SHANK LENGTH
ND7/16-3US			10.88"	1.35"	2.43"	0.35 lbs	3"
ND1/2-3US			10.88"	1.35"	2.43"	0.40 lbs	3"
ND1/4-3US			10.88"	1.28"	2.43"	0.25 lbs	3"
ND3/8-3US			10.88"	1.28"	2.43"	0.30 lbs	3"
ND11/32-3US			10.88"	1.28"	2.43"	0.30 lbs	3"
ND3/16-3US			10.88"	1.28"	2.43"	0.25 lbs	3"
ND5/16-3US			10.88"	1.28"	2.43"	0.30 lbs	3"
ND6N1HD			11.42"	3.62"	1.77"	1.00 lbs	-
NDS5N1			5.91"	3.74"	1.18"	0.28 lbs	-
NDSET7US			6.88"	1.40"	15.00"	2.00 lbs	-
			SHANK TYPE	SHANK LENGTH	TIP TYPE		
ND7/16-3US			Round	3"	7/16"		
ND1/2-3US			Round	3"	1/2"		
ND1/4-3US			Round	3"	1/4"		
ND3/8-3US			Round	3"	3/8"		
ND11/32-3US			Round	3"	11/32"		
ND3/16-3US			Round	3"	3/16"		
ND5/16-3US			Round	3"	5/16"		
ND6N1HD			-	-	3/16", 1/4", 5/16", 3/8", 7/16", 9/16"		
NDS5N1			-	-	3/16", 1/4", 5/16", 3/8", 1/2"		
NDSET7US			-	-	1/2", 1/4", 3/8", 5/16", 7/16", 3/16", and 11/32"		

 **WE'VE GOT IT
MADE IN AMERICA™**

HAND TOOLS | DRIVERS

HAND TOOLS

T-HANDLE HEX KEYS



Designed to efficiently tighten and loosen hex screws.

- T-handle design allows for greater torque application
- Hex key blade - long and short for flexible use
- Forged heavy duty steel blade for durable usage
- Over molded grip for comfortable feel

SPECIFICATIONS

MODEL #	STOCK #	DESCRIPTION			
THEX6-1/2	582878	1/2" T-Handle Hex Key w/ 8" Shank			
HEIGHT	WIDTH	DEPTH	WEIGHT	SET LENGTH	
THEX6-1/2	9.75"	4.75"	1"	0.91 lbs	8"

THEX6-1/2

FOLDING HEX KEY SETS



HEX-8

Convenient and reliable, these folding hex key sets will help you get the job done quickly and easily.

- Precision made hex keys reduce slipping and stripping
- Set easily stores in metal case to reduce lost keys and damage
- Strong durable body doubles as a handle



HEX-5

SPECIFICATIONS

MODEL #	STOCK #	DESCRIPTION			
HEX-8	582876	8-Piece Folding Hex Key Set			
HEX-5	582875	5-Piece Folding Hex Key Set			
HEIGHT	WIDTH	DEPTH	WEIGHT	SET LENGTH	
HEX-5	5.25"	1.5"	0.75"	0.68 lbs	3/32", 7/64", 1/8", 9/64", 5/32", 3/16", 7/32", & 1/4"
HEX-8	5.25"	1.5"	0.75"	0.89 lbs	3/16", 7/32", 1/4", 5/16", & 3/8"

HAND TOOLS

TORPEDO LEVEL



LVLTOR9

This professional grade, hands-free level is perfect for pipe and conduit work.

- Integrated light illuminates vials for better visibility
- Three leveling vials set at 0°, 45°, and 90°
- Lightweight and durable aluminum construction
- Easy-to-read, high impact, acrylic bubble vials
- V-grooved edge helps hold the level in place on pipe or conduit
- Four powerful magnets for hands-free operation
- Requires 2 AAA batteries (not included)

SPECIFICATIONS

MODEL #	STOCK #	DESCRIPTION			
LVLTOR9	582818	9" Torpedo Level			
HEIGHT	WIDTH	DEPTH	WEIGHT	SET INCLUDES	
LVLTOR9	9"	1.5"	0.75"	0.54 lbs	Magnets and lighted vials

CONDUIT BENDING LEVEL

MCBLEVEL



High visibility vials are easy to read and set for measurements at 0°, 30°, 45°, and 90°.

- Set screw secures level to conduit
- Four powerful magnets for hands free operation
- Easy-to-read, high impact, acrylic bubble vials
- V-grooved edge helps hold the level in place on pipe or conduit
- Lightweight and durable aluminum construction

SPECIFICATIONS

MODEL #	STOCK #	DESCRIPTION			
MCBLEVEL	582816	6" Conduit Bending Level			
HEIGHT	WIDTH	DEPTH	WEIGHT	SET INCLUDES	
MCBLEVEL	6.31"	1.88"	0.63"	0.31 lbs	Magnets, thumb screw for attaching to conduit

HAND TOOLS

SPEEDSET™ CONDUIT LEVEL

SS01



Multi-function conduit level: conduit spacer, torpedo level, and dog-leg preventer.

- Equipped with strong magnets for easy leveling
- Create perfect bends every time
- Will easily attach to any 3/4", 1", and 1-1/4" bender head
- Multiple conduit bends exactly the same every time without comparing them to each other

SPECIFICATIONS

MODEL #	STOCK #	DESCRIPTION		
SS01	582815	SPEEDSET™ Conduit Level		
HEIGHT	WIDTH	DEPTH	WEIGHT	
SS01	0.5"	2.38"	2"	0.20 lbs

HAND TOOLS

ELECTRICIAN'S SHOULDER POUCH

BAGESP



Convenient shoulder bag provides a lightweight, durable tool carrier that can be hand-carried, slung over your shoulder, or attached to a belt. Features 16 storage pockets and the patented Flip Lid™ Spill Guard.

- Multiple carrying options: shoulder strap, padded handle, belt loop tunnel
- Constructed from 2400D ballistic weave for durability
- 16 tool storage pockets

SPECIFICATIONS

MODEL #	STOCK #	DESCRIPTION		
BAGESP	587387	Electrician's Shoulder Pouch		
HEIGHT	WIDTH	DEPTH	INTERNAL CAPACITY	
BAGESP	12"	8.5"	6.5"	247 Cubic Inches/4 Liters

HAND TOOLS

TOOL BAG BACKPACK

PROBAGBP



Our tool bag backpack allows you to comfortably carry your tools on your back or by hand. Easy opening zippers allow access to the numerous tool storage compartments. Enclosed pouches are located on both external and internal surfaces to provide additional tool storage security.

- Constructed from 2400D ballistic weave for durability
- 58 storage pockets, zippered pouches, and tool loops
- Non-tipping rubber base is wear and water resistant
- Fully molded base allows bag to stand freely

SPECIFICATIONS

MODEL #	STOCK #	DESCRIPTION		
PROBAGBP	67599040	Tool Backpack		
HEIGHT	WIDTH	DEPTH	INTERNAL CAPACITY	
PROBAGBP	13.78"	7.87"	18.7"	1, 235 Cubic Inches

5-POCKET LEATHER TOOL POUCH

POUCH4



The 5-Pocket Leather Tool Pouch with electrical tape chain is designed for easy storage and tool access.

- Saddle leather resistant to fade and stain
- Washer rivets for extra strength
- Fits belts up to 3" wide

SPECIFICATIONS

MODEL #	STOCK #	DESCRIPTION		
POUCH4	582831	5 Pocket Tool Pouch		
HEIGHT	WIDTH	DEPTH	INTERNAL CAPACITY	
POUCH4	9.25"	7"	3"	Leather

ELECTRICIAN'S WORK GLOVES

GLOVE1L



High dexterity electrician's gloves with anti-slip fingertips.

- Anti-slip finger tips for secure holding of wire and tools
- Padded palm for protection and secure grip
- Wrapped index finger for durability
- Breathable spandex back for comfortable fit and feel
- Touchscreen compatible index finger and thumb

SPECIFICATIONS

MODEL #	STOCK #	DESCRIPTION
GLOVE1L	587390	Electrician's Work Gloves - Large
PRIMARY MATERIAL		SECONDARY MATERIAL
GLOVE1L	Breathable Spandex	Synthetic Leather



HAND TOOLS

CANVAS ZIPPER BAG

BAG12



Our canvas zipper bag is a very convenient storage place for pliers, wrenches, and other tools that you use daily.

- Durable, heavy-duty cotton canvas bag
- Sturdy plastic resin zipper

SPECIFICATIONS

MODEL #	STOCK #	DESCRIPTION		
BAG12	582828	12" Canvas Zipper Bag		
	HEIGHT	WIDTH	DEPTH	WEIGHT
BAG12	12"	7"	0.25"	0.13 lbs

4-PIECE ELECTRICIAN'S TOOL KIT

EKIT-4



Complete with 10-18 AWG wire stripper, 9-in-1 multi-bit screwdriver, high leverage side cutting pliers, and nylon carrying pouch.

10-18 AWG WIRE STRIPPER - MODEL # S1018STR

- Strips and cuts 10-18 AWG solid and 12-20 AWG stranded wire
- Stainless steel construction is durable and corrosion resistant
- Double-dipped grip provides comfortable fit
- Specially designed stainless steel cutting blades provide fast and clean wire stripping
- Serrated nose grasps the cable for easy twisting and pulling
- Spring loaded for self-opening action
- Not intended for cutting bolts or steel cable

HIGH LEVERAGE SIDE CUTTING PLIERS - MODEL # SCP9

- Induction hardened cutting blades ensure efficient and lasting cutting surfaces for hard and soft wire
- File teeth on jaws help remove burrs in conduit
- Cuts ACSR, screws, nails, and most hardened wire
- Curved handle and ergonomic molded grip for comfortable use
- Drop forged CRV steel for durability

9-IN-1 MULTI-BIT SCREWDRIVER - MODEL # SD9N1

- Includes 6 bits and 3 nut drivers for multi-purpose use
- Cushion grip handle for comfortable use and maximum torque application

SPECIFICATIONS

MODEL #	STOCK #	DESCRIPTION			
EKIT-4	US: 591587	4-Piece Electrician's Tool Kit			
EKIT-4	CAD: 591588	4-Piece Electrician's Tool Kit			
	HEIGHT	WIDTH	DEPTH	WEIGHT	INCLUDES
EKIT-4	4.25"	9.75"	2.25"	0.16 lbs	S1018STR, SCP9, and SD9N1

HAND TOOLS

CABLE SPLICERS KIT

CSK5



Cable Splicers Kit is ideal for prepping category cable installation.

- Lock holds blades closed for storage
- Serrated lower blades grip wire for non-slip cutting action
- Includes marking pen
- Includes leather carrying pouch
- Includes boot knife for sheathing and removing cable jackets

SPECIFICATIONS

MODEL #	STOCK #	DESCRIPTION		
CSK5	597242	Cable Splicers Kit		
HEIGHT	WIDTH	DEPTH	WEIGHT	
CSK5	8.25"	8.63"	12.25"	4.40 lb.



BEKIT-3 BASIC ELECTRICIAN'S KIT

BEKIT-3



The perfect start to your electrical work tool box. These three tools are exactly what you need to get started on any simple electrical work.

- The S1018STR stainless steel wire stripper is rust resistant
- The SD9N1 Multi-Bit Screwdriver includes #1 & #2 Phillips tips, 1/4", 5/16", & 3/8" hex drivers, 3/16" & 1/4" slotted tips, and #1 & #2 square tips
- The 40116N NCV has a detection range of 100-600V AC

SPECIFICATIONS

MODEL #	STOCK #	DESCRIPTION		
BEKIT-3	631368	Basic Electrician's Kit		
HEIGHT	WIDTH	DEPTH	WEIGHT	
BEKIT-3	10.25"	7.88"	0.75"	2 lbs

VDV HAND TOOLS

Southwire offers a full line of VDV tools including cable cutters, strippers, crimpers and punchdown tools, as well as cable tracers and testers. Our goal is to provide professional tools that exceed customers' expectations for quality, performance and features — tools that make a difference on the real-world jobsite.

- VDV Cutters
- VDV Prep & Strip
- VDV Terminate



VDV HAND TOOLS

PROFESSIONAL DATACOMM SNIPS

ESP-1



These snips provide very precise control and offer a patented design with unique spring-loaded action.

- Ergonomic, spring-loaded design for precise control
- Lock holds snips closed for storage
- Double-dipped, textured grip
- Strips 19 AWG and 23 AWG
- Serrated blade grips wire as it cuts

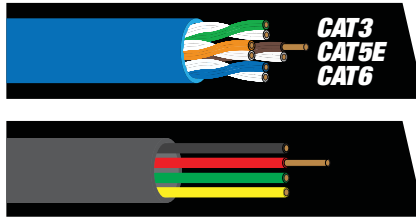

SPECIFICATIONS

MODEL #	STOCK #	DESCRIPTION
ESP-1	587437	Professional DataComm Snips

ELECTRICIAN'S SCISSORS

ESS-1



Unlike regular scissors or shears, the serrated blades of this powerful scissor keeps wire from slipping out of the jaws. Cutting through hardware cloth, cable, wire netting, and other difficult-to-cut materials becomes as easy task.

- Strips 19 AWG & 23 AWG
- Strong, tempered steel
- Nickel-plated finish resists corrosion
- Scraper and file on outside of both blades

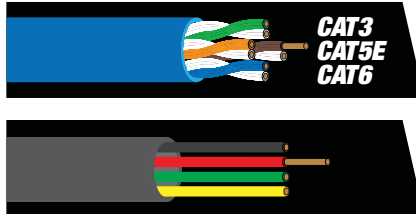

SPECIFICATIONS

MODEL #	STOCK #	DESCRIPTION
ESS-1	587438	Electrician's Scissors

VDV HAND TOOLS

ELECTRICIAN'S SPLICING KIT

ESP-KIT



This 5 piece kit includes ESP scissors, a boot knife, a marker, and an LED pen-light in a rugged leather pouch.

- Spring-loaded scissors for precise cuts
- Serrated blade grips wires as it cuts
- Stripping notches for 19 and 22 AWG wire
- Double-dipped texture grip
- LED pen-light illuminates work space

SPECIFICATIONS

MODEL #	STOCK #	DESCRIPTION	HEIGHT	WIDTH	DEPTH	WEIGHT
ESP-KIT	597242	Electrician's Splicing Kit				
ESP-KIT			8.25"	8.63"	12.25"	4.40 lbs

VDV | SPLICING KIT

VDV HAND TOOLS

COAX CCS CUTTER

CCSX-C1



Many coax cables today have a copper clad steel (CCS) center conductor. This specially designed cutter is made to reliably cut CCS coax that might damage standard cable cutters.

- Reliably cuts copper-clad steel coax without blade damage
- V-notch blade doesn't deform cable
- Forged steel
- Double-dipped textured grip

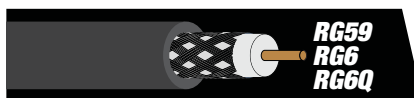

SPECIFICATIONS

MODEL #	STOCK #	DESCRIPTION
CCSX-C1	587433	CCSX-C1 Coax CCS Cutter

ROUND CABLE CUTTER

X-C1



The stainless steel X-C1 has two cable cutting profiles: a long nose for cutting in confined spaces and a cable tie cutting tip. This is perfect for coax and twisted pair cabling.

- Curved blade profile for clean cuts
- Elongated nose to reach and cut in tight places
- Stainless steel for corrosion resistance
- Double-dipped textured grip
- Cutting areas for small and large round cable

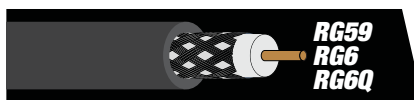

SPECIFICATIONS

MODEL #	STOCK #	DESCRIPTION
X-C1	587467	X-C1 Round Cable Cutter

VDV HAND TOOLS

RADIAL CUTTER/STRIPPER FOR TWISTED PAIR

XSR-T1



Cut and strip twisted pair cabling quickly and easily with one tool.

- Rotate knob to adjust depth of the cut
- Strips outer jacket without nicking wires



SPECIFICATIONS

MODEL #	STOCK #	DESCRIPTION
XSR-T1	587470	Radial Cutter/Stripper for Twisted Pair

KEY STRIP TOOL FOR TWISTED PAIR

SK-T1



The Key Strip Tool for Twisted Pair quickly strips outer cable jackets from CAT 3, 5, 5e and 6 data cable.

- Quickly removes outer cable jacket
- Three positions for different size cables
- Cost effective



SPECIFICATIONS

MODEL #	STOCK #	DESCRIPTION
SK-T1	587461	SK-T1 Key Strip Tool for Twisted Pair

COAX TRIGGER STRIP TOOL

ST-C1



The rotary-style coax stripper performs a fast and precise two-level strip in one easy step.

- Standard two-level strip exposes 1/4" of center conductor and 1/4" of shield braid
- Innovative "trigger" design improves control and fits comfortably in hand
- Use with RG59, RG6 and RG6 quad shield coax

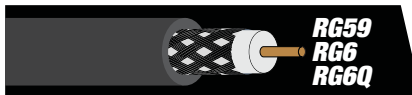

SPECIFICATIONS

MODEL #	STOCK #	DESCRIPTION
ST-C1	587462	Coax Trigger Strip Tool

VDV HAND TOOLS

AUTOMATIC WIRE STRIPPER FOR COAX

SA-C1



The SA-C1 Automatic Wire Stripper for Coax allows for quick, two-step stripping of RG6 and RG6Q cable.

- Traditional automatic design preferred by many installers
- 2-level strip: Center conductor and outer jacket

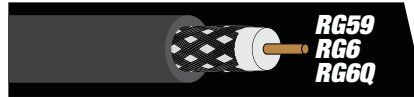

SPECIFICATIONS

MODEL #	STOCK #	DESCRIPTION
SA-C1	587459	Automatic Wire Stripper for Coax

COAX CUTTER/STRIPPER

XS-C1



The XS-C1 Coax Cutter/Stripper cuts and strips coax cable and features a cable tie cutting tip.

- Cuts and strips RG59, RG6, and RG6Q quad shield coax
- Stainless steel for corrosion resistance
- Textured double dip handles for better grip and comfort
- Tip is designed to cleanly cut cable ties

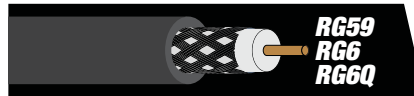

SPECIFICATIONS

MODEL #	STOCK #	DESCRIPTION
XS-C1	587468	Coax Cutter/Stripper

VDV HAND TOOLS

COAX PREP TOOL

CPT-CF1



The time-saving Coax Prep Tool is a 3-in-1 tool for loosening/tightening cable TV "F" connectors from jacks. It also flares the cable jacket and holds the connector during assembly.

- Easily loosens stubborn connectors
- Flares coax jacket for easy connector insertion
- Holds cable TV "F" connector during cable insertion
- Double-molded grip for long-lasting comfort

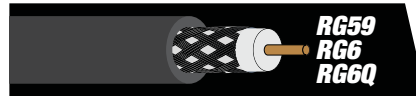

SPECIFICATIONS

MODEL #	STOCK #	DESCRIPTION
CPT-CF1	587434	Coax Prep Tool

VDV | PREP TOOL

VDV HAND TOOLS

PROFESSIONAL IMPACT PUNCHDOWN TOOL

PDTP-K1



*Includes both 110 and 66 style blades
Easy to pull out wire hook and spudger tools*

The Professional Impact Punchdown Tool includes 110 & 66 twist-to-lock blades and features unique pull out accessory tools in a comfortable, durable tool body.

- Terminates twisted pair category cable into wall jacks and patch panels for phone and data communications
- Includes both 110 and 66-style, long life, metal injection molded blades
- Comfortable double-molded tool body
- Wire hook and spudger accessory tools pull out one-handed with easy-to-use thumb studs
- Covered blade storage

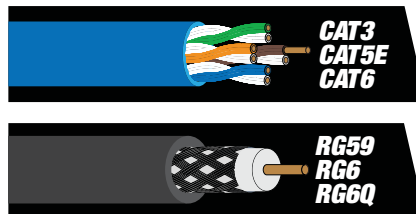

BLADES AVAILABLE SEPARATELY

- B1 Reversible 66 Punch/110 Cut-Only Punchdown Blade
- B2 Reversible 110 Cut/Punch Punchdown Blade
- B3 Reversible 66 Cut/Punch Punchdown Blade

SPECIFICATIONS

MODEL #	STOCK #	DESCRIPTION
PDTP-K1	587455	Professional Impact Punchdown Tool

COMFORT GRIP 110-STYLE PUNCHDOWN TOOL

PDTC-1



The Comfort Grip 110-Style Punchdown Tool easily terminates 110-style blocks on patch panels and wall jacks.

- Punch down 110-style jacks or patch panels
- Soft rubber comfort grip
- 110-style blade terminates cable and trims excess wire



SPECIFICATIONS

MODEL #	STOCK #	DESCRIPTION
PDTC-1	587454	Comfort Grip 110-Style Punchdown Tool

VDV HAND TOOLS

RATCHETING PHONE & DATA CRIMP TOOL

RJCR-T1



The RJCR-T1 Ratcheting Phone & Data Crimp Tool cuts and strips voice and data cable. It also crimps RJ45 data connectors as well as RJ11/RJ12 phone modular plugs.

- Ratcheting tool cuts, strips, and crimps phone and data cable
- Comfortable double-molded grips help to orient the tool
- Compatible with standard RJ45, RJ11/RJ12, and RJ22 modular plugs
- Locks closed for easy storage

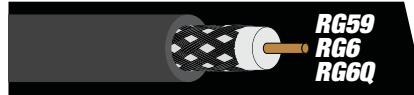

SPECIFICATIONS

MODEL #	STOCK #	DESCRIPTION
RJCR-T1	587458	Ratcheting Phone & Data Crimp Tool

VDV HAND TOOLS

COMPACT VOICE & DATA CRIMP TOOL

RJCC-T1



This all-in-one tool cuts and strips both phone and data cable. It also crimps RJ45 (data) as well as RJ11/RJ12, and RJ22 (phone) modular plugs.

- Cuts, strips, and crimps data and voice cable
- Compact and versatile design
- Compatible with RJ45, RJ11/RJ12 and RJ22 plugs
- Convenient handle lock for easy storage
- For network and phone applications

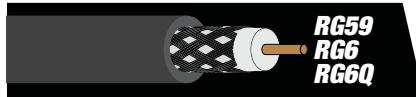

SPECIFICATIONS

MODEL #	STOCK #	DESCRIPTION
RJCC-T1	587457	Compact Voice & Data Crimp Tool

RATCHET CRIMP TOOL – COAX CABLE TV “F” HEX CONNECTORS

RCT-D1



The compound leverage design delivers high crimp force with low hand force, and the near-parallel jaw action delivers precision crimps. The RCT-D1 is where power meets precision.

- Compound leverage design provides powerful crimping with low hand force
- Near-parallel travel crimping jaw for precise crimps
- Precision ratchet with release
- Convenient handle lock for easy storage
- Die set available separately:
 - D1 Die Set - Cable TV F Coax

SPECIFICATIONS

MODEL #	STOCK #	DESCRIPTION
RCT-D1	587456	RCT-C1 Ratchet Crimp Tool – Coax
D1	587435	D1 Replacement Die Set – Cable TV “F” Coax

VDV HAND TOOLS

NETWORK TOOL KIT

KIT-TP1



This 13-piece Network Tool Kit includes the tools you need to cut, strip, terminate, and install data cabling.

- Complete 13 piece kit for terminating data cable
- Make custom length patch cables
- Includes tools to cut, strip, and terminate data cabling
- Kit includes:
 - Compact 3-in-1 Cut/Strip/Crimp Tool
 - Comfort Grip Punchdown Tool
 - Reversible Screwdriver
 - 10 RJ45 Connectors
 - Rugged Tool Case

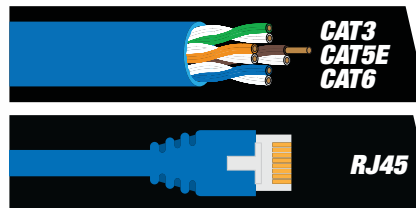

SPECIFICATIONS

MODEL #	STOCK #	DESCRIPTION
KIT-TP1	587441	Network Tool Kit

CRIMPING LONG NOSE PLIERS- UR/UY/UG

LNP6DC-1



Long Nose Pliers for crimping IDC (insulation displacement) UR, UY, and UG type connectors.

- Crimps UR/UY/UG connectors
- Strips 22-24 AWG wire
- Induction hardened cutting blade
- Hot-rivet joint for smooth action and long life
- 6" length

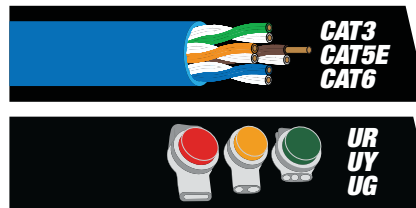

SPECIFICATIONS

MODEL #	STOCK #	DESCRIPTION
LNP6DC-1	587442	Crimping Long Nose Pliers – UR/UY/UG

VDV HAND TOOLS

MULTI-CONNECTOR COMPRESSION COAX CRIMP TOOL

CCM-C1



When you need versatility, Multi-Connector Compression Coax Crimp Tool is 3-way adjustable to work with F, BNC, and RCA compression connectors as well as RG59/6/6Q and RG7/11 coax cable.

- 3-way chuck can be positioned for cable TV "F", RCA, and BNC connectors
- Rotatable connector cradle accommodates RG59, RG6Q, RG6 as well as larger RG7 and RG11 cable
- Thumb-wheel for fine-tuning crimping length
- For cable TV, satellite, security, and home theater applications
- Comfortable double-molded grips are indexed to help orient the tool

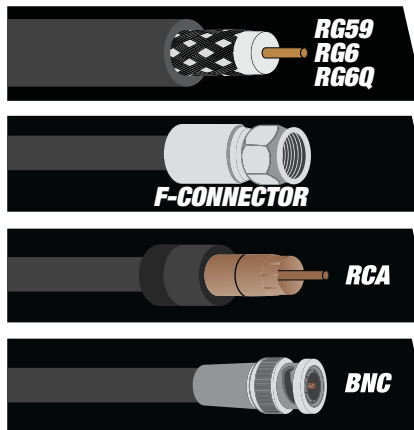

SPECIFICATIONS

MODEL #	STOCK #	DESCRIPTION
CCM-C1	591403	Multi-Connector Compression Coax Crimp Tool

VDV HAND TOOLS

COMPACT COMPRESSION COAX CRIMP TOOL FOR "F" CONNECTORS

CCF-C1



The CCF-C1 Compact Compression Coax Crimp Tool securely attaches "F" type connectors to coax cable in one easy step. CCF-C1 features double-molded handles to provide a comfortable grip and powerful crimping force.

- Compatible with RG59, RG6, and RG6Q coaxial cable
- Simple, compact, and powerful
- Double-molded handles for durability and grip

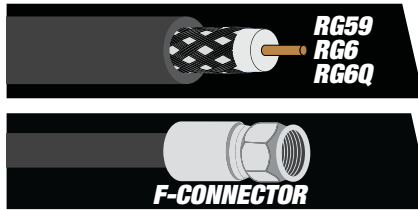

SPECIFICATIONS

MODEL #	STOCK #	DESCRIPTION
CCF-C1	591402	Compact Compression Coax Crimp Tool - Cable TV "F"

VDV HAND TOOLS

CABLE TV TOOL KIT

KIT-C1



This 13-piece Cable TV Tool Kit includes all the tools you need to cut, strip, crimp, and install "F" connectors onto coax cable.

- Complete 13-piece kit for terminating coax
- Make custom length coax patch cables
- All 3 tools included to cut, strip, and crimp coax
- Kit includes:
 - Round Cable Cutter
 - Radial "Trigger" Stripper
 - Compression Crimper for "F" Connectors
 - 10 "F" Connectors for RG6 Coax
 - Rugged Tool Case

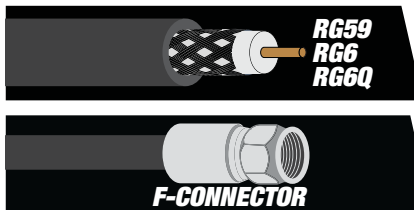

SPECIFICATIONS

MODEL #	STOCK #	DESCRIPTION
KIT-C1	587440	Cable TV Tool Kit

VDV HAND TOOLS

COAX 3-IN-1 CRIMP TOOL

HCT-C1



The stainless steel Southwire 3-in-1 Crimp Tool cuts and strips coax as well as crimps Cable TV "F" hex-style connectors.

- One tool cuts, strips, and crimps coax cable
- Crimps "F" connectors
- Stainless steel for corrosion resistance
- Double-dipped textured grip

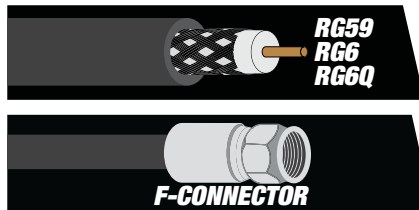

SPECIFICATIONS

MODEL #	STOCK #	DESCRIPTION
HCT-C1	587439	Coax 3-in-1 Crimp Tool

FISHING & BENDING

Introducing our unique line of fish tapes, featuring a spiral extruded polymer design that reduces the amount of effort required to push or pull the fish tape through EMT and PVC conduit. Unlike fiberglass, the SIMpull Fish Tapes are kink resistant and virtually unbreakable, ensuring maximum efficiency*.

**As compared to Southwire steel and fiberglass fish tapes.*

- Non-Conductive Tip Fish Tape
- Flexible Metal Leader Fish Tape
- Fish Tape Tube
- Steel Fish Tape
- Fish Tape Leader
- Glow-In-The-Dark Fish Sticks
- Hand Benders



FISHING & BENDING

SIMpull™ NON-CONDUCTIVE TIP FISH TAPE



The SIMpull™ Non-Conductive Tip Fish Tape has a spiral extruded polymer design that reduces the amount of effort required to push or pull the fish tape through EMT or PVC conduit. It also features a non-conductive leader.

- 75', 100', 125' non-conductive tip fish tape
- High impact, durable case for lasting durability and use
- Non-conductive leader reduces risk of damage to wire jackets
- Leader glows in the dark for easier tracking on low-light conditions
- Spiral extruded polymer allows for faster install time
- Spiral extruded polymer does not rust and will not break when folded
- Weighs less than steel
- 40% lower coefficient of friction than Southwire steel fish tape



NON-CONDUCTIVE LEADER



DOES NOT BREAK WHEN FOLDED



GLOW IN THE DARK



FASTER INSTALL TIME



DOES NOT RUST



WEIGHS LESS THAN STEEL

SPECIFICATIONS

MODEL #	STOCK #	DESCRIPTION			
FTSP45-75NCT	630298	SIMpull™ Fish Tape 4.5mm 75'/22.8M, Large Case			
FTSP45-125NCT	631637	SIMpull™ Fish Tape 4.5mm 125'/38.1M, Large Case			
LENGTH	WIDTH	DEPTH	DIAMETER	WEIGHT	
FTSP45-75NCT	75'	13"	1.75"	4.5 mm	3.10 lbs
FTSP45-125NCT	125'	13"	1.75"	4.5 mm	2.50 lbs

FISHING & BENDING | FISH TAPE

FISHING & BENDING

SIMpull™ FLEXIBLE METAL LEADER FISH TAPE



The SIMpull™ Flexible Metal Leader Fish Tape has a spiral extruded polymer design that reduces the amount of effort required to push or pull the fish tape through EMT or PVC conduit.

- 75', 100', 125' flexible metal leader tip fish tape
- High impact, durable case for lasting durability and use
- 360° swiveling leader for ease of guidance through turns
- Spiral extruded polymer allows for faster install time
- Spiral extruded polymer does not rust and will not break when folded
- Weighs less than steel
- 40% lower coefficient of friction than Southwire steel fish tape

SPECIFICATIONS

MODEL #	STOCK #	DESCRIPTION			
FTSP45-75FML	598970	SIMpull™ Fish tape 4.5mm 75'/22.8M, Large Case			
FTSP45-125FML	598969	SIMpull™ Fish tape 4.5mm 125'/38.1M, Large Case			
LENGTH	WIDTH	DEPTH	DIAMETER	WEIGHT	
FTSP45-75FML	75'	13"	1.75"	4.5 mm	2.2 lbs
FTSP45-125FML	125'	13"	1.75"	4.5 mm	2.5 lbs



NON-CONDUCTIVE
LEADER



DOES NOT BREAK
WHEN FOLDED



SWIVELING
LEADER



FASTER INSTALL
TIME



DOES NOT
RUST



WEIGHS LESS
THAN STEEL

FISHING & BENDING

SIMpull™ FISH TAPE TUBE

FTSP45-240FMLT



The 4.5mm 240' SIMpull™ Fish Tape Tube is designed to offer superior performance on long runs. With the same features and benefits as previous models, the fish tape tube is designed for longer runs of up to 240 feet. It also includes both a glow-in-the-dark, non-conductive leader and a flexible metal leader on opposite ends, allowing for usage in both empty and filled conduit.

- Spiral extruded polymer design reduces the amount of effort required to push or pull the fish tape through EMT or PVC conduit
- Combines the strength of a steel fish tape with greater flexibility than fiberglass fish tapes
- Flexible metal leader on one end and non-conductive leader on the opposite end
- 40% lower coefficient of friction than Southwire steel fish tape

SPECIFICATIONS

MODEL #	STOCK #	DESCRIPTION		
FTSP45-240FMLT	631647	SIMpull™ Fish Tape 4.5mm 240' Flexible Metal Leader/Non Conductive, Tube		
	HEIGHT	WIDTH	DEPTH	WEIGHT
FTSP45-240FMLT	250'	22.75"	3.4"	3.4 lbs

FISHING & BENDING | FISH TAPE

FISHING & BENDING

STEEL FISH TAPE



Southwire's steel fish tape reaches easily above ceilings, under carpets, and through walls to install wire. The fish tape is available in multiple lengths.

- Available in the following lengths: 25', 50', 65', 125', and 240'
- Laser etched footage markings to help identify length of pull
- High impact, durable case for long lasting performance and use
- Specially treated steel fish tape for longer life and easier pulling

SPECIFICATIONS

MODEL #	STOCK #	DESCRIPTION
FTS1/8-240	582798	1/8" Fish Tape Steel 240'
FTS1/8-125	582799	1/8" Fish Tape Steel 125'
FTS1/8-65	582800	1/8" Fish Tape Steel 65'
FTS1/8-50	582801	1/8" Fish Tape Steel 50'
FTS1/8-25	582802	1/8" Fish Tape Steel 25'
FTS1/4-25	582797	1/4" Flat Fish Tape 25', flat plastic tip

	LENGTH	WIDTH	DEPTH	WEIGHT	TAPE WIDTH
FTS1/8-240	240'	7"	1.75"	7.4 lbs	1/8"
FTS1/8-125	125'	13"	1.75"	4.4 lbs	1/8"
FTS1/8-65	65'	8.75"	1.13"	2.4 lbs	1/8"
FTS1/8-50	50'	8.75"	1.13"	1.6 lbs	1/8"
FTS1/8-25	25'	7"	1.00"	0.8 lbs	1/8"
FTS1/4-25	25'	7"	1.00"	0.8 lbs	1/4"

FISHING & BENDING

FISH TAPE LEADER



Flexible leader guides steel tapes through conduit and helps reduce the challenge of pulling and pushing.

- Flexible 13" leader easily attaches to 1/8" steel fish tapes
- Assists in guiding steel fish tapes through conduit turns and bends

SPECIFICATIONS

MODEL #	STOCK #	DESCRIPTION				
FTFL13	582806	Fish Tape Leader 13' for Steel Fish Tapes				
	LENGTH	WIDTH	DEPTH	WEIGHT	TAPE WIDTH	EYELET CAPACITY
FTFL13	14.25"	0.38"	0.25"	2 oz	3/16	5 x 12 AWG Upstripped, 7 x 10 AWG Bare

FISHING & BENDING

GLOW-IN-THE-DARK FISH STICK



Make fishing through walls or over ceilings easier with our Glow-in-the-Dark Fish Sticks.

- Luminescent fiberglass rods glow in the dark and recharge with most available light sources
- 3/16" flexible rods resist splintering and cracking
- Individual sections easily screw together to form single rod
- Includes bullet nose with eyelet and hook attachments

SPECIFICATIONS

MODEL #	STOCK #	DESCRIPTION			
FS15	582793	15' Glow-in-the-Dark Fish Stick (Includes Bullet Nose with Eyelet & Hook Attachments)			
FS12	582794	12' Glow-in-the-Dark Fish Stick (Includes Bullet Nose with Eyelet & Hook Attachments)			
FS8	582795	8' Glow-in-the-Dark Fish Stick (Includes Bullet Nose with Eyelet & Hook Attachments)			
	ASSEMBLED LENGTH	WIDTH	DEPTH	WEIGHT	STICK LENGTH
FS15	180"	0.19"	0.19"	13.3 oz	3x5' Pieces
FS12	144"	0.19"	0.19"	13.9 oz	3x4' Pieces
FS8	96"	0.19"	0.19"	8 oz	4x2' Pieces

FISHING & BENDING

CONDUIT BENDERS



Reliably and repeatedly perform common bends, such as stub-ups, offsets, back-to-back, and saddle bends. Available in 1", 3/4", and 1/2" sizes.

- Durable cast metal heads
- Swaged steel handle permits insertion of conduit to correct overbends
- Raised and highly visible bender markings are cast on both sides of the bender head
- Large serrated step provides greater control and helps prevent slipping when applying force

SPECIFICATIONS

MODEL #	STOCK #	DESCRIPTION			
MCB1	582814	1" EMT Conduit Bender with Handle (Ductile Iron Head)			
MCB3/4	582812	3/4" EMT Conduit Bender with Handle (Aluminum Head)			
MCB1/2	582813	1/2" EMT Conduit Bender with Handle (Aluminum Head)			
	HEIGHT	WIDTH	DEPTH	WEIGHT	CONDUIT SIZE
MCB1	1.75"	12"	45"	13 lbs	1" EMT 3/4" Rigid
MCB3/4	1.25"	9"	39"	9 lbs	3/4" EMT 1/2" Rigid
MCB1/2	1.25"	8"	39"	7 lbs	1/2" EMT

FISHING & BENDING

12" HAND CABLE BENDER

CB12-350



The CB12-350 has a forged, one-piece, steel design for quick and easy bending. It is ideal for bending 350 MCM cables.

- Black oxide finish for corrosion resistance
- Dipped grip handles
- Forged one-piece design
- High strength steel
- 350 MCM cable capacity

SPECIFICATIONS

MODEL #	STOCK #	DESCRIPTION		
CB12-350	587391	CB12-350 12" 350 MCM Hand Cable Bender		
HEIGHT	WIDTH	DEPTH	WEIGHT	
CB12-350	12"	1.86"	.85"	0.95 lbs

14" HAND CABLE BENDER

CB14-500



The CB14-500 has a forged, one-piece, steel design for quick and easy bending. It is ideal for bending 500 MCM cables.

- Black oxide finish for corrosion resistance
- Dipped grip handles
- Forged one-piece design
- High strength steel
- 500 MCM cable capacity

SPECIFICATIONS

MODEL #	STOCK #	DESCRIPTION		
CB14-500	587392	CB14-500 14" 500 MCM Hand Cable Bender		
HEIGHT	WIDTH	DEPTH	WEIGHT	
CB14-500	14.25"	2.22"	1.35"	1.6 lbs

WARRANTY

WHAT DOES THIS WARRANTY COVER?

FIVE-YEAR LIMITED WARRANTY ON CONTRACTOR EQUIPMENT

Under Southwire's Contractor Equipment 5-Year Limited Warranty, Southwire Company, LLC warrants that all Southwire Contractor Equipment will be free from manufacturer defects for a period of five (5) years from the date of the original end user's purchase. However, electrical components and consumable parts such as ropes, blades, dies, draw studs, grips, are excluded from this 5-Year Limited Warranty and are subject to the One-Year warranty terms. Under this 5-Year Limited Warranty, the following are also excluded and Southwire Company, LLC will have no liability for any of the following: normal wear and tear resulting from product use and damage arising out of misuse, abuse, modification, and improper product maintenance. This warranty also does not cover Southwire Contractor Equipment products that have been modified by any party other than Southwire Company, LLC or its authorized third party designee. This 5-Year Limited Warranty is not transferable to or enforceable by any person other than the product's original end user.

THREE-YEAR LIMITED WARRANTY ON MATERIAL BOXES

Under Southwire's Material Boxes 3-Year Limited Warranty, Southwire Company, LLC warrants that all Southwire Material Boxes will be free from manufacturer defects for a period of three (3) years from the date of the original end user's purchase. Under this Three-Year Limited Warranty for Material Boxes, the following are excluded and Southwire Company, LLC will have no liability for any of the following: normal wear and tear resulting from product use and damage arising out of misuse, abuse, modification, and improper product maintenance. This warranty also does not cover Material Boxes that have been modified by any party other than Southwire Company, LLC or its authorized third party designee. This 3-Year Limited Warranty is not transferable to or enforceable by any person other than the product's original end user.

ONE-YEAR LIMITED WARRANTY ON ELECTRICAL COMPONENTS AND CONSUMABLE PARTS (WITH 5-YEAR WARRANTY)

Under Southwire's 1-Year Limited Warranty, Southwire Company, LLC warrants that all electrical components and consumable parts such as ropes, blades, dies, draw studs, grips will be free from manufacturer defects for a period of one-year from the date of the original end user's purchase. Under this 1-Year Limited Warranty, Southwire Company, LLC will have no liability for any of the following: normal wear and tear resulting from product use and damage arising out of misuse, abuse, modification, and improper product maintenance. This warranty also does not cover Southwire electrical components and consumable parts that have been modified by any party other than Southwire Company, LLC or its authorized third party designee. This 1-Year Limited Warranty is not transferable to or enforceable by any person other than the product's original end user.

ONE-YEAR LIMITED WARRANTY (STAND ALONE)

Under Southwire's 1-Year Limited Warranty, Southwire Company, LLC warrants that this product will be free from manufacturer defects for a period of one-year from the date of the original end user's purchase. Under this 1-Year Limited Warranty, Southwire Company, LLC will have no liability for any of the following: normal wear and tear resulting from product use and damage arising out of misuse, abuse, modification, and improper product maintenance. This warranty also does not cover Southwire products that have been modified by any party other than Southwire Company, LLC or its authorized third party designee. This 1-Year Limited Warranty is not transferable to or enforceable by any person other than the product's original end user.

EXCLUSION OF INCIDENTAL, CONSEQUENTIAL, INDIRECT, SPECIAL AND PUNITIVE DAMAGES

SOUTHWIRE MAKES NO WARRANTY THAT SOUTHWIRE CONTRACTOR EQUIPMENT PRODUCTS WILL BE MERCHANTABILITY OR FIT FOR ANY PARTICULAR PURPOSE. SOUTHWIRE MAKES NO OTHER WARRANTY, EXPRESSED OR IMPLIED, OTHER THAN THE RELEVANT WARRANTY SPECIFICALLY SET FORTH IN THIS WARRANTY SECTION. SOUTHWIRE WILL NOT BE LIABLE FOR ANY INCIDENTAL, CONSEQUENTIAL, INDIRECT, SPECIAL, OR PUNITIVE DAMAGES FOR ANY BREACH OF THIS LIMITED LIFETIME WARRANTY.

Some states do not allow the exclusion or limitation of incidental or consequential damages, so the above limitation or exclusion may not apply to you.

LIMITED WARRANTY AND LIMITATION OF LIABILITY ON SOUTHWIRE METERS & TESTERS

Southwire Company, LLC warrants this product to be free from defects in material and workmanship for five years from the date of purchase. This warranty does not cover fuses, disposable batteries, or damage arising from an accident, neglect, misapplication, contamination, modification, improper maintenance or repair, operation outside of specifications, or abnormal handling of the product. Southwire's sole liability, and the purchaser's exclusive remedy, for any breach of this warranty is expressly limited to Southwire's repair or replacement of the product. Whether Southwire repairs or replaces the product will be a determination that Southwire makes at its sole discretion. SOUTHWIRE MAKES NO WARRANTY THAT THE PRODUCT WILL BE MERCHANTABILITY OR FIT FOR ANY PARTICULAR PURPOSE. SOUTHWIRE MAKES NO OTHER WARRANTY, EXPRESSED OR IMPLIED, OTHER THAN THE WARRANTY SPECIFICALLY SET FORTH HEREIN. SOUTHWIRE WILL NOT BE LIABLE FOR ANY INCIDENTAL, CONSEQUENTIAL, INDIRECT, SPECIAL, OR PUNITIVE DAMAGES FOR ANY BREACH OF THIS WARRANTY.

This warranty is void if this product is used for rental purposes. No product reseller is authorized to extend any other warranty on Southwire's behalf relating to this product, and no such reseller warranty will be binding on Southwire. If you have a warranty claim, or if the product needs to be serviced during or after the warranty period set forth above, please contact the Customer Service Department at 855-SWTTOOLS (855-798-6657). The sender is responsible for all shipping, freight, insurance, and packaging costs associated with sending a product to Southwire. Southwire will not be responsible for lost or damaged products returned pursuant to this warranty. All products returned to Southwire under this warranty should be mailed to:

WARRANTY



Southwire™

TOOLS & EQUIPMENT

HAND TOOLS CATALOG

GET SOCIAL WITH US:



[/SOUTHWIRETOOLS](#)
[/SOUTHWIRETOOLSLATINO](#)



[@SOUTHWIRETOOLS](#)



[@SOUTHWIRETOOLS](#)



[SOUTHWIRETOOLS](#)

[SOUTHWIRETOOLS.COM](#) | 1-855-SWTOOLS

All Trademarks or Registered Trademarks (TM/®) are owned or licensed by Southwire Company.
Any other TM/® - Trademark or Registered Trademark of Southwire Company.